

NuDAQ[®]

ACL-8216

**16-bit High Resolution
Data Acquisition Card**

User's Guide

@Copyright 1996~2000 ADLINK Technolgoy Inc.
All Rights Reserved.

Manual Rev. 4.10: April 15, 2000

The information in this document is subject to change without prior notice in order to improve reliability, design and function and does not represent a commitment on the part of the manufacturer.

In no event will the manufacturer be liable for direct, indirect, special, incidental, or consequential damages arising out of the use or inability to use the product or documentation, even if advised of the possibility of such damages.

This document contains proprietary information protected by copyright. All rights are reserved. No part of this manual may be reproduced by any mechanical, electronic, or other means in any form without prior written permission of the manufacturer.

Trademarks

NuDAQ, ACL-8216 are registered trademarks of ADLINK Technology Inc.,

Other product names mentioned herein are used for identification purposes only and may be trademarks and/or registered trademarks of their respective companies.

Getting service from ADLINK

Customer Satisfaction is always the most important thing for ADLINK Tech Inc. If you need any help or service, please contact us and get it.

ADLINK Technology Inc.			
Web Site	http://www.adlink.com.tw		
Sales & Service	service@adlink.com.tw		
Technical Support	NuDAQ	nudaq@adlink.com.tw	
	NuDAM	nudam@adlink.com.tw	
	NuIPC	nuipc@adlink.com.tw	
	NuPRO	nupro@adlink.com.tw	
	Software	sw@adlink.com.tw	
	AMB	amb@adlink.com.tw	
TEL	+886-2-82265877	FAX	+886-2-82265717
Address	9F, No. 166, Jian Yi Road, Chungho City, Taipei, 235 Taiwan, R.O.C.		

Please inform or FAX us of your detailed information for a prompt, satisfactory and constant service.

Detailed Company Information			
Company/Organization			
Contact Person			
E-mail Address			
Address			
Country			
TEL		FAX	
Web Site			
Questions			
Product Model			
Environment to Use	OS _____ Computer Brand _____ M/B: CPU: Chipset: Bios: Video Card: Network Interface Card: Other:		
Challenge Description			
Suggestions for ADLink			



Table of Contents

How to Use This Guide	iii
Chapter 1 Introduction	1
1.1 Features.....	2
1.2 Specifications.....	2
1.4 Software Support.....	4
Chapter 2 Installation.....	5
2.1 What You Have	5
2.2 Unpacking.....	5
2.3 ACL-8216's Layout.....	6
2.4 Jumper and DIP Switch Description	8
2.5 Base Address Setting.....	8
2.6 Analog Input Channel Configuration	11
2.7 DMA Channel Setting.....	11
2.8 Internal/External Trigger Setting	12
2.9 Clock Source Setting.....	13
2.10 IRQ Level Setting.....	14
2.11 D/A Reference Voltage Setting.....	14
2.12 Connectors Pin Assignment	16
2.13 Daughter Board Connection	18
Chapter 3 Registers Format	21
3.1 I/O Port Address.....	21
3.2 A/D Data Registers & Status Control Register.....	22
3.3 A/D Channel Multiplexer Register.....	23
3.4 A/D Range Control Register.....	24
3.5 A/D Operation Mode Control Register.....	25
3.6 Clear Interrupt Register	26
3.7 Software Trigger Register.....	26
3.8 Digital I/O register.....	26
3.9 D/A Output Register	28
3.10 Internal Timer/Counter Register	28
Chapter 4 Operation Theorem.....	29
4.1 A/D Conversion.....	29
4.2 D/A Conversion	32

4.3	Digital Input and Output.....	33
4.4	Timer/Counter Operation.....	33
Chapter 5	C/C++ Library.....	39
5.1	Installation.....	39
5.2	8216_Initial.....	40
5.3	8216_Switch_Card_No.....	41
5.4	8216_DI.....	42
5.5	8216_DI_Channel.....	42
5.6	8216_DO.....	43
5.7	8216_DA.....	44
5.8	8216_AD_Input_Mode.....	46
5.9	8216_AD_Set_Channel.....	47
5.10	8216_AD_Set_Range.....	49
5.11	8216_AD_Set_Mode.....	50
5.12	8216_AD_Soft_Trig.....	52
5.13	8216_AD_Acquire.....	53
5.14	8216_CLR_IRQ.....	54
5.15	8216_AD_DMA_Start.....	54
5.16	8216_AD_DMA_Status.....	57
5.17	8216_AD_DMA_Stop.....	57
5.18	8216_AD_INT_Start.....	59
5.19	8216_AD_INT_Status.....	60
5.20	8216_AD_INT_Stop.....	60
5.21	8216_AD_Timer.....	61
5.22	8216_Timer_Start.....	62
5.23	8216_Timer_Read.....	62
5.24	8216_Timer_Stop.....	63
Chapter 6	Calibration & Utilities.....	65
6.1	What do you need.....	65
6.2	VR Assignment.....	65
6.3	A/D Adjustment.....	66
6.4	D/A Adjustment.....	66
Appendix A	Demo Programs.....	69
Product Warranty/Service.....		71

How to Use This Guide

This manual is designed to help you use the ACL-8216. The manual describes how to modify various settings on the ACL-8216 card to meet your requirements. It is divided into six chapters:

- Chapter 1, "Introduction," gives an overview of the product features, applications, and specifications.
- Chapter 2, "Installation," describes how to install the ACL-8216. The layout of ACL-8216 is shown, the switch setting for base address, and jumper setting for analog input channel configuration, reference voltage setting, trigger source, interrupt level and DMA channel are specified. The connectors' pin assignment and how to connect the outside signal are described.
- Chapter 3, "Registers format," describes the details of register format and structure of the ACL-8216, this information is very important for the programmers who want to control the hardware by low-level programming.
- Chapter 4, "Operation Theorem" describes how to operate the ACL-8216. The A/D, D/A, DIO and timer/counter functions are introduced. Also, some programming concepts are specified.
- Chapter 5, "C/C++ Library," describes the C++ Library for DOS environment.
- Chapter 6, "Calibration and utilities," describes how to calibrate the ACL-8216 for accurate measurement.

1

Introduction

The ACL-8216 is a high performance, high resolution multi-function data acquisition card for the IBM PC or compatible computers.

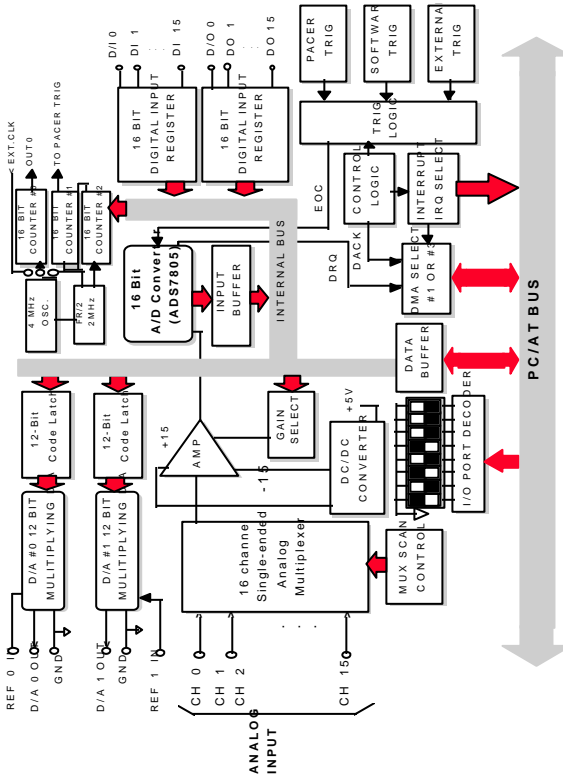


Figure 1.1 ACL-8216 BLOCK DIAGRAM

The ACL-8216 series is designed to combine all the data acquisition functions, such as A/D, D/A, DIO, and timer/counter in a single board, The high-end specifications of the card makes it ideal for wide range of applications requiring high resolution 16-bit data acquisition at low cost. The Figure 1.1 shows the block diagram of the ACL-8216.

The ACL-8216 Series features 16 single-ended inputs or 8 differential inputs at up to 100 Khz, 2 channels multiplying 12-bit double-buffered analog output, 16 digital inputs and 16 digital outputs, and one timer/counter channel.

1.1 Features

The ACL-8216 High Resolution Multi-function Data Acquisition Card provides the following advanced features:

- AT-Bus
- 16-bit high resolution analog input
- 16 single-ended or 8 differential analog input channels
- Bipolar input signals
- Programmable gain of x1, x2, x4, x8
- On-chip sample & hold
- Two 12-bit monolithic multiplying analog output channels
- 16 digital output channels
- 16 digital input channels
- 3 independent programmable 16-bit down counters
- Programmable sampling rate of up to 100KHz
- Three A/D trigger modes: software trigger, programmable pacer trigger, and external pulse trigger.
- AT interrupt IRQ capability: 9 IRQ levels (IRQ3~IRQ15) are jumper selectable.
- Integral DC-to-DC converter for stable analog power source
- 37-pin D-type connector
- Compact size: half-size PCB

1.2 Specifications

• Analog Input (A/D)

- **Converter:** ADS7805 or equivalent, successive approximation type
- **Resolution:** 16-bit

- **Number of channels:** 16 single-ended or 8 differential
 - **Input Range:** (programmable)
 - Bipolar : $\pm 10V, \pm 5V, \pm 2.5V, \pm 1.25V$
 - **Conversion Time:** 8 μ sec
 - **Sampling Rate:**
 - 100KHz maximum for single channel
 - 20KHz maximum for multi-channels multiplexing
 - **Overvoltage protection:** Continuous $\pm 35V$ maximum
 - **Differential Linearity Error:** ± 2 LSB
 - **Accuracy:** 0.003%, ± 1 LSB
 - **Input Impedance:** 10 M Ω / 5pF
 - **AD conversion trigger sources:** Software, Pacer, and External
 - **Data Transfer:** Pooling, Interrupt, DMA
- .. **Analog Output (D/A)**
- **Converter:** DAC7541 or equivalent, monolithic multiplying
 - **Resolution:** 12-bit
 - **Number of channels:** 2 double-buffered analog outputs
 - **Output Range:**
 - Internal reference: (unipolar) 0~5V or 0~10V
 - External reference: (unipolar) max. +10V or -10V
 - **Settling Time:** 30 μ sec
 - **Linearity:** $\pm 1/2$ bit LSB
 - **Output driving capability:** $\pm 5mA$ max.
- .. **Digital I/O (DIO)**
- **Channel:** 16 TTL compatible inputs and outputs
 - **Input Voltage:**
 - Low: Max. 0.8V
 - High: Min. +2.0V
 - **Input Load:**
 - Low: +0.5V @ -0.2mA max.
 - High: +2.7V @ +20 μ A max.
 - **Output Voltage:**
 - Low: Max. 0.5V
 - High: Min. +2.7V
 - **Driving Capacity:**
 - Low: Max. +0.5V at 8.0mA (Sink)
 - High: Min. 2.7V at 0.4mA(Source)
- .. **Programmable Counter**
- **Device:** 8254

- **A/D pacer:** 32-bit timer(two 16-bit counter cascaded together) with a 2MHz clock base
 - **Counter:** One 16-bit counter with an internal 2MHz clock base or external clock
 - **Pacer Output:** 0.00046 Hz ~ 100K Hz
- .. **General Specifications**
- **I/O Base Address:** 16 consecutive address location
 - **Interrupt IRQ:** IRQ3, 5,6,7,9,10,11,12,15
 - **DMA Channel:** CH1 or CH3
 - **Connector:** 37-pin D-type connector
 - **Operating Temperature:** 0° C ~ 55° C
 - **Storage Temperature:** -20° C ~ 80° C
 - **Humidity:** 5 ~ 95%, non-condensing
 - **Power Consumption:**
 - +5 V @ 420 mA maximum
 - +12 V @ 240 mA maximum
 - **Dimension:** 163 mm (L) X 123mm(W)

1.4 Software Support

1.4.1 Programming Library

For the customers who are writing their own programs, we provide MS-DOS Borland C/C++ programming library.

ACLS-DLL2 is the Development Kit for NuDAQ ISA-Bus Cards with Analog I/O, windows 3.1/95(98)/NT. ACLS-DLL2 can be used for many programming environments, such as VC++, VB, Delphi. ACLS-DLL2 is included in the ADLINK CD. It need license.

1.4.2 LabView Driver

The ACLS-LVIEW includes the ACL-8316/8312' s Vis, which is used to interface with NI' s LabView software package. The ACLS-LVIEW supports Windows-95(98)/NT. ACLS-LVIEW is included in the ADLINK CD. It need license.

2

Installation

This chapter describes how to install the ACL-8216. At first, the contents in the package and unpacking information that you should care about are described. The jumpers and switches setting for the ACL-8216's base address, analog input channel configuration, interrupt IRQ level, voltage source, etc. are also specified.

2.1 What You Have

In addition to this *User's Manual*, the package includes the following items:

- ACL-8216 Enhanced Multi-function Data Acquisition Card
- ADLINK CD

If any of these items is missing or damaged, contact the dealer from whom you purchased the product. Save the shipping materials and carton in case you want to ship or store the product in the future.

2.2 Unpacking

Your ACL-8216 card contains sensitive electronic components that can be easily damaged by static electricity.

The card should be done on a grounded anti-static mat. The operator should be wearing an anti-static wristband, grounded at the same point as the anti-static mat.

Inspect the card module carton for obvious damage. Shipping and handling may cause damage to your module. Be sure there are no shipping and handling damages on the module before processing.

After opening the card module carton, extract the system module and place it only on a grounded anti-static surface component side up.

Again inspect the module for damage. Press down on all the socketed IC's to make sure that they are properly seated. Do this only with the module place on a firm flat surface.

Note: DO NOT APPLY POWER TO THE CARD IF IT HAS BEEN DAMAGED.

You are now ready to install your ACL-8216.

2.3 ACL-8216's Layout

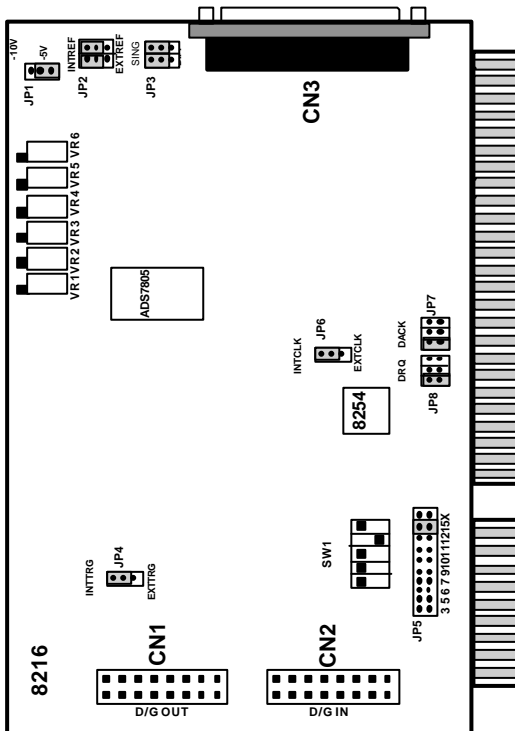


Figure 2.1 PCB Layout of the ACL-8216

2.4 Jumper and DIP Switch Description

You can change the ACL-8216's channels and the base address by setting jumpers and DIP switches on the card. The card's jumpers and switches are preset at the factory. You can change the jumper settings for your own applications.

A jumper switch is closed (sometimes referred to as "shorted") with the plastic cap inserted over two pins of the jumper. A jumper is open with the plastic cap inserted over one or no pin(s) of the jumper.

2.5 Base Address Setting

The ACL-8216 requires 16 consecutive address locations in the I/O address space. The base address of the ACL-8216 is restricted by the following conditions.

1. The base address must be within the range *Hex 000* to *Hex 3FF*.
2. The base address should not conflict with any PC reserved I/O address. see Appendix A.
3. The base address must not conflict with any add-on card on your own PC. Please check your PC before installing the ACL-8216.

The ACL-8216's base address of registers is selected by an 6 positions DIP switch **SW1**. The default setting of base address is set to be **HEX 220**. All possible base address combinations are listed as Table 2.2. You may modify the base address if the address *HEX 220* has been occupied by another add-on card.

SW1 : Base Address = Hex 220

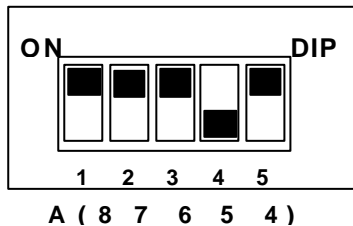


Figure 2.2 Default Base Address Setting

I/O port Address(Hex)	1 A8	2 A7	3 A6	4 A5	5 A4
200-20F	ON (0)	ON (0)	ON (0)	ON (0)	ON (0)
210-21F	ON (0)	ON (0)	ON (0)	ON (0)	OFF (1)
220-22F (default)	ON (0)	ON (0)	ON (1)	OFF (1)	ON (0)
230-23F	ON (0)	ON (0)	ON (0)	OFF (1)	OFF (1)
:					
300-30F	OFF (1)	ON (0)	ON (0)	ON (0)	ON (0)
:					
3F0-3FF	OFF (1)	OFF (1)	OFF (1)	OFF (1)	OFF (1)

Table 2.2 Possible Base Address Combinations

A0, ..., A9 is corresponding to PC Bus address lines

A9 is always set as "1".

How to define the base address for the ACL-8216 ?

The DIP1 to DIP6 in the switch SW1 are one to one corresponding to the PC bus address line A8 to A4. A0~A3 are always 0, and A9 is always 1. If you want to change the base address, you can only change the values of A8 to A4 (the shadow area of below table). The following table is an example, which shows you how to define the base address as **Hex 220**

Base Address: **Hex 220**

2		2				0			
1	0	0	0	1	0	0	0	0	0
A9	A8	A7	A6	A5	A4	A3	A2	A1	A0

2.6 Analog Input Channel Configuration

The ACL-8216 offer 16 single-ended or 8 differential analog input channels. The jumper JP3 controls the analog input channel configuration. The settings of JP3 is specified as following illustration.

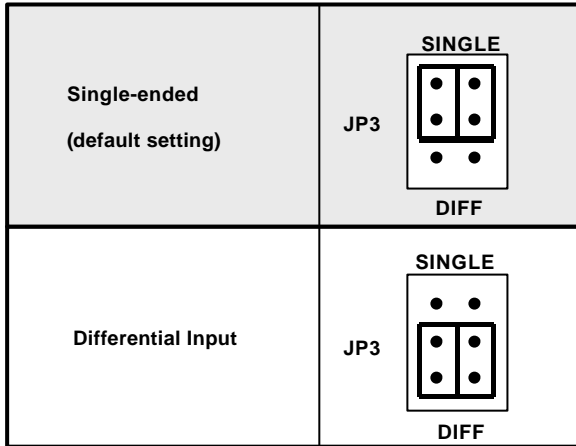


Figure 2.3 Analog Input Channels Configuration

2.7 DMA Channel Setting

The A/D data transfer of ACL-8216 is designed with DMA transfer capability. The setting of DMA channel 1 or channel 3 is controlled by the jumpers JP8 and JP7. The possible settings are shown below.

Note: On floppy disk only machine, we suggest you to set DMA level 3. If you have hard disk equipped computer, level 1 is preferable.

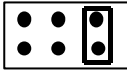
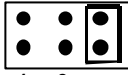
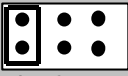

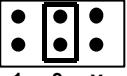
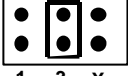
NO DMA	<p>DACK JP7</p>  <p>1 3 X</p>	<p>DRQ JP8</p>  <p>1 3 X</p>
DMA 1 (Default)	<p>DACK JP7</p>  <p>1 3 X</p>	<p>DRQ JP8</p>  <p>1 3 X</p>
DMA 3	<p>DACK JP7</p>  <p>1 3 X</p>	<p>DRQ JP8</p>  <p>1 3 X</p>

Figure 2.4 DMA Channel Setting

2.8 Internal/External Trigger Setting

The A/D conversion trigger source of ACL-8216 comes from internal or external. The internal or external trigger source is setting by JP4, as shown on Figure 2.5. Note that there are two internal on-board trigger sources, one is the software trigger and the other is the programmable pacer trigger, which is controlled by the mode control register(see section 4.5).

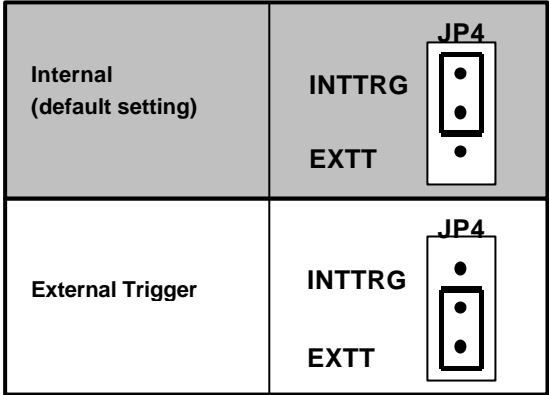


Figure 2.5 Trigger Source Setting

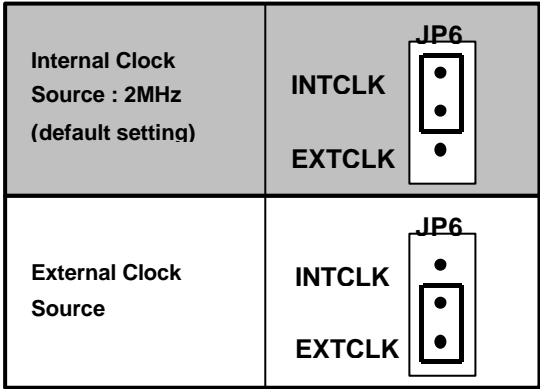


Figure 2.6 Timer's Clock Source Setting

2.9 Clock Source Setting

The 8254 programmable interval timer is used in the ACL-8216. It provides 3 independent channels of 16-bit programmable down counters. The input of counter 2 is connected to a precision 2MHz oscillator for internal pacer. The input of counter 1 is cascaded from the output of counter 2. The channel 0 is free for user's applications. There are two selections for the clock source of channel 0: the internal 2MHz clock or the external clock signal from connector CN3 pin 37. The setting of clock is shown as Figure 2.6.

2.10 IRQ Level Setting

The ACL-8216 can connect to any one of the interrupt lines of the PC I/O channel. The interrupt line is selected by the jumper JP7. If you wish to use the interrupt capability of ACL-8216, you must select an interrupt level and place the jumper in the appropriate position to enable the particular interrupt line.

The default interrupt level is IRQ15, which is selected by placing the jumper on the pins in row number 15. Figure 2.7 shows the default interrupt jumper setting IRQ15. You only remove the jumper from IRQ15 to other new pins, if you want to change to another IRQ level.

Note: Be aware that there is no other add-on card shares the same interrupt level at the same system.

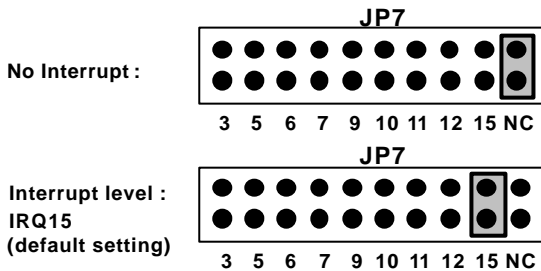


Figure 2.7 IRQ Level Setting

2.11 D/A Reference Voltage Setting

The D/A converter's reference voltage source can be internal or external generated. The external reference voltage comes from connector CN3 pin 31 (*ExtRef1*) and pin12 (*ExtRef2*), see section 3.1. The reference source of D/A channel 1 and channel 2 are selected by JP2, respectively. Their possible settings are shown as below:

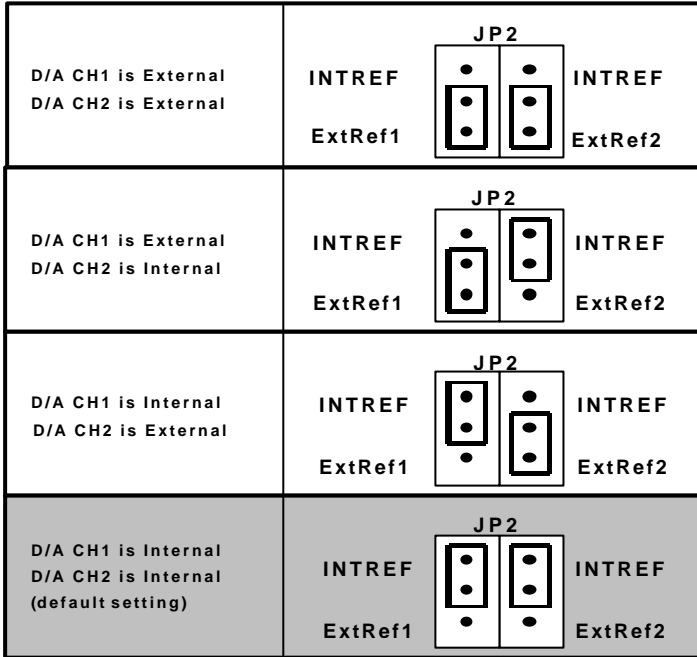


Figure 2.8 D/A Voltage Setting

The internal voltage is -5V or -10V which can be selected by JP1. The possible configurations are specified as Figure 2.9. Note that the internal reference voltage is used only when the JP2 or JP3 is set to internal reference.

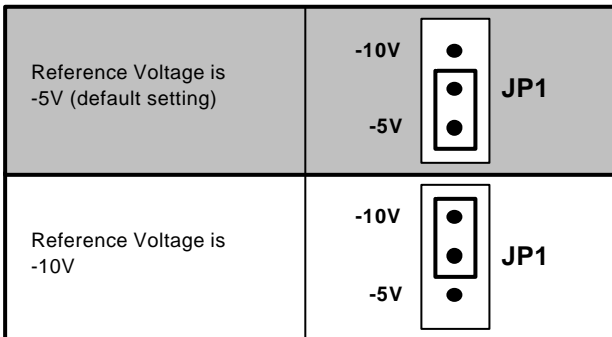


Figure 2.9 Internal Reference Voltage Setting

2.12 Connectors Pin Assignment

The ACL-8216 comes equipped with two 20-pin insulation displacement connectors - CN1 and CN2 and one 37-pin D-type connector - CN3. The CN1 and CN2 are located on board and CN3 located at the rear plate.

CN1 is used for digital signal output, CN2 for digital signal input, CN3 for analog input, analog output and timer/counter's signals. The pin assignment for each connectors are illustrated in the Figure 3.1 ~ Figure 3.3.

- CN 2: Digital Signal Input (*DI 0 - 15*)

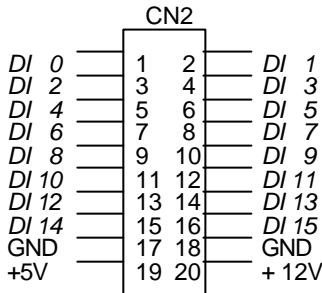


Figure 3.1. Pin Assignment of CN2

- CN 1: Digital Signal Output (*DO 0 - 15*)

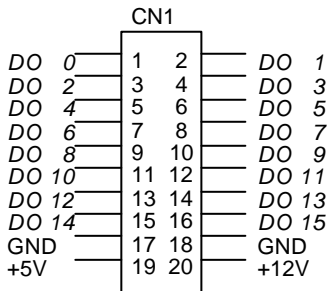


Figure 3.2. Pin Assignment of CN1

Legend:

DO n: Digital output signal channel *n*

DI n: Digital input signal channel *n*

GND : Digital ground

- CN 3: Analog Input/Output & Counter/Timer
(for single-ended connection)

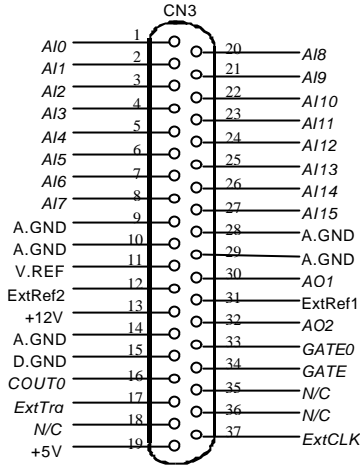


Figure 3.3a. Pin Assignment of CN3

- CN 3: Analog Input/Output & Counter/Timer
(for differential connection)

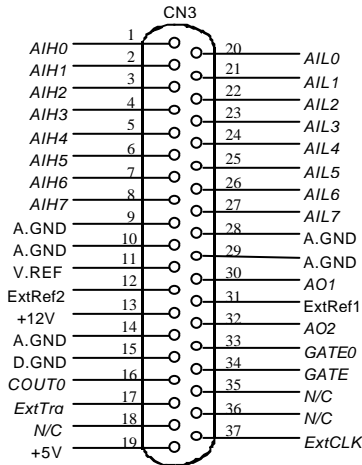


Figure 3.3b. Pin Assignment of CN3

Legend:

AIN: Analog Input Channel *n* (single-ended)
AIHn: Analog High Input Channel *n* (differential)
AILn: Analog Low Input Channel *n* (differential)
ExtRef n: External Reference Voltage for D/A CH *n*
AOn: Analog Output Channel *n*
ExtCLK: External Clock Input
ExtTrig: External Trigger Signal
CLK: Clock input for 8254 Counter 0
GATE: Gate input for 8254 Counter 1 & 2
COUt n: Signal output of Counter *n*
V.ERF: Voltage Reference
A.GND: Analog Ground
GND: Ground

2.13 Daughter Board Connection

The ACL-8216 can be connected with five different daughter boards, ACLD-8125, ACLD-9137, 9182, 9185, and 9188. The functionality and connections are specified as follows.

2.13.1 Connect with ACLD-8125

The ACLD-8125 has a 37-pin D-sub connector, which can connect with ACL-8216 through 37-pin assemble cable. The most outstanding feature of this daughter board is a CJC (cold junction compensation) circuit on board. You can directly connect the thermocouple on the ACL-8125 board.

2.13.2 Connect with ACLD-9137

The ACLD-9137 is a direct connector for the card which is equipped with 37-pin D-sub connector. This board provides a simple way for connection. It is very suitable for the simple applications that do not need complex signal condition before the A/D conversion is performed.

2.13.3 Connect with ACLD-9182

The ACLD-9182 is a 16 channel isolated digital input board. This board is connected with CN1 of ACL-8216 via 20-pin flat cable. The

advantage of board is an 500Vdc isolation voltage is provided, and it can protect your PC system from damage when an abnormal input signal is occurred.

2.13.4 Connect with ACLD-9185

The ACLD-9185 is a 16 channel SPDT relay output board. This board is connected with CN2 of ACL-8216 via 20-pin flat cable. by using this board, you can control outside device through the digital output signals.

2.13.5 Connect with ACLD-9188

ACLD-9188 is a general purpose terminal board for all the card which comes equipped with 37-pin D-sub connector.

3

Registers Format

The detailed descriptions of the register format and structure of the ACL-8216 are specified in this chapter. This information is quite useful for the programmer who wish to handle the card by low-level program.

In addition, the low level programming syntax is introduced. This information can help the beginners to operate the ACL-8216 in the shortest learning time.

3.1 I/O Port Address

The ACL-8216 requires 16 consecutive addresses in the PC I/O address space. The Table 4.1 shows the I/O address of each register with respect to the base address. The function of each register also be shown.

I/O Address	Read	Write
Base + 0	Counter 0	Counter 0
Base + 1	Counter 1	Counter 1
Base + 2	Counter 2	Counter 2
Base + 3	Not Used	8254 Counter Control
Base + 4	A/D low byte	CH1 D/A low byte
Base + 5	A/D high byte	CH1 D/A high byte
Base + 6	DI low byte	CH2 D/A low byte
Base + 7	DI high byte	CH2 D/A high byte
Base + 8	Status Control	Clear Interrupt Request
Base + 9	Not Used	A/D Range Control
Base + 10	Not Used	Channel MUX

Base + 11	Not Used	Mode Control
Base + 12	Not Used	Software A/D trigger
Base + 13	Not Used	DO low byte
Base + 14	Not Used	DO high byte
Base + 15	Not Used	Not Used

Table 3.1 I/O Address

3.2 A/D Data Registers & Status Control Register

The ACL-8216 provides 16 single-ended or 8 differential A/D input channels, the digital data will store in the A/D data registers. The 16 bits A/D data is put into two 8 bits registers. The low byte data (8 LSBs) are put in address BASE+4 and the high byte data is put in address BASE+5. A Status Control Register(Base+8) is used to check if the D/A conversion is ready. An DRDY bit is used to indicate the status of A/D conversion. DRDY goes to low level means A/D conversion is completed.

Address : BASE + 4 and BASE + 5

Attribute: read only

Data Format:

Bit	7	6	5	4	3	2	1	0
BASE+4	AD7	AD6	AD5	AD4	AD3	AD2	AD1	AD0
BASE+5	AD15	AD14	AD13	AD12	AD11	AD10	AD9	AD8

AD15 .. AD0: Analog to digital data. AD15 is the Most Significant Bit (MSB). AD0 is the Least Significant Bit(LSB).

The A/D converted data is in Binary Two' s Complement data output format. Refer to Table 3.3 for ideal output code.

Description	Analog Input	Digital Output	
		Binary Two' s Complement	Hex Code
Full Scale Range	$\pm 10V$		
Least Signification Bit (LSB)	$305\mu V$		
+Full Scale	$9.999695V$	0111 1111 1111 1111	7FFF
MidScale	$0V$	0000 0000 0000 0000	0000
One LSB below MidScale	$-305\mu V$	1111 1111 1111 1111	FFFF

-Full Scale	-10V	1000 0000 0000 0000	8000
-------------	------	---------------------	------

Table 3.2 Ideal Input Voltage and Output Code

Address : BASE +8

Attribute: read only

Data Format:

Bit	7	6	5	4	3	2	1	0
BASE+8	-	-	DRDY	-	-	-	-	-

DRDY: Data Ready Signal.

1: A/D data is not ready

0: A/D conversion is completed.

It will be set to 1, when reading the low byte.

3.3 A/D Channel Multiplexer Register

This register is used to control the A/D channels to be converted. It's a write only register. When the channel number is written to the register, the multiplexer switches to the new channel and await for conversion.

Address : BASE + 10

Attribute: write only

Data Format:

Bit	7	6	5	4	3	2	1	0
BASE+10	X	X	CS 1	CS 0	CL 3	CL 2	CL 1	CL0

CLn: multiplexer channel number.

CL2 is MSB, and CL0 is LSB.

CS0 and CS1 are used to determine which MPC508A chip is selected. The MPC508A is used to multiplex channel from channel, when CS0 is set as 1, the analog input channels from 0 to 7 is selectable, and CS1 is set, the ch 8 to ch 15 can be selectable. When both CS0 and CS1 are set as 1, it means the analog input is differential mode. The possible analog input channel selections are listed as the table below.

Bit Channel	7	6	5	4	3	2	1	0
	X	X	CS 1	CS 0	CL3	CL2	CL 1	CL0

S.E. CH0	X	X	0	1	0	0	0	0
S.E. CH1	X	X	0	1	0	0	0	1
S.E. CH2	X	X	0	1	0	0	1	0
S.E. CH3	X	X	0	1	0	0	1	1
S.E. CH4	X	X	0	1	0	1	0	0
S.E. CH5	X	X	0	1	0	1	0	1
S.E. CH6	X	X	0	1	0	1	1	0
S.E. CH7	X	X	0	1	0	1	1	1

S.E. CH8	X	X	1	0	1	0	0	0
S.E. CH9	X	X	1	0	1	0	0	1
S.E. CH10	X	X	1	0	1	0	1	0
S.E. CH11	X	X	1	0	1	0	1	1
S.E. CH12	X	X	1	0	1	1	0	0
S.E. CH13	X	X	1	0	1	1	0	1
S.E. CH14	X	X	1	0	1	1	1	0
S.E. CH15	X	X	1	0	1	1	1	1
D.I. CH0	X	X	1	1	0	0	0	0
D.I. CH1	X	X	1	1	0	0	0	1
D.I. CH2	X	X	1	1	0	0	1	0
D.I. CH3	X	X	1	1	0	0	1	1
D.I. CH4	X	X	1	1	0	1	0	0
D.I. CH5	X	X	1	1	0	1	0	1
D.I. CH6	X	X	1	1	0	1	1	0
D.I. CH7	X	X	1	1	0	1	1	1

S.E.: Single-ended Analog Input

D.I.: Differential Analog Input

3.4 A/D Range Control Register

The A/D range register is used to adjust the analog input ranges for A/D channels. Two factor will effect the input range: Gain and Bipolar/Unipolar. Both of these issues can be controlled by this register. The Table 4.2 shows the relationship between the register data and the A/D input range.

Address : BASE + 9

Attribute: write only

Data Format:

Bit	7	6	5	4	3	2	1	0
BASE+9	X	X	X	X	X	X	G1	G0

G1	G0	GAIN	Mode	Input Range
0	0	1	Bipolar	$\pm 10V$
0	1	2	Bipolar	$\pm 5V$
1	0	4	Bipolar	$\pm 2.5V$
1	1	8	Bipolar	$\pm 1.25V$

3.5 A/D Operation Mode Control Register

The A/D operation includes the analog signal conversion and the data transformation. This register controls the internal trigger mode and data transformation method. It is initialized as software trigger and program polling transfer when your PC is reset or power on. The details of the A/D operation is illustrated in Chapter 5. There are four operation modes shown as following .

Address : BASE + 11

Attribute: write only

Data Format:

Bit	7	6	5	4	3	2	1	0
BASE+11	X	X	X	X	X	S2	S1	S0

S2	S1	S0	Operation Mode Description
0	0	0	Internal trigger is disable
0	0	1	software trigger and program polling (default)
0	1	0	timer pacer trigger and DMA transfer
1	1	0	timer pacer trigger and interrupt transfer.

Note:

1. When your system power on or reset, the A/D operation will be initialized as " software trigger and program polling" mode.
 2. No matter which mode is selected, the external trigger is available if the JP4 is set to be external trigger.
-

-
3. As long as not the DMA mode is not used, the program polling is always possible. The synchronization of A/D conversion and data transfer should be concerned when use program polling.
 4. The interrupt will be occurred after end of conversion if the "timer pacer trigger and interrupt transfer" mode is selected. If you want to use pacer trigger and interrupt transfer mode, please enable the IRQ level.
-

3.6 Clear Interrupt Register

The Interrupt Status Register is used to clear the interrupt status for next new interrupt can be generated. If the ACL-8216 is in interrupt data transfer mode, a hardware status flag will be set after each A/D conversion. You have to clear the status flag by just writing any data to this register, let the ACL-8216 can generate next interrupt if a new A/D conversion is happen.

Address : BASE + 8

Attribute: write only

Data Format:

Bit	7	6	5	4	3	2	1	0
BASE+8	X	X	X	X	X	X	X	X

3.7 Software Trigger Register

If you want to generate a trigger pulse to the ACL-8216 for A/D conversion, you just write any data to this register, and then the A/D converter will be triggered.

Address : BASE + 12

Attribute: write only

Data Format:

Bit	7	6	5	4	3	2	1	0
BASE+12	X	X	X	X	X	X	X	X

3.8 Digital I/O register

There are 16 digital input channels and 16 digital output channels

are provided by the ACL-8216. The address Base + 6 and Base + 7 are used for digital input channels, and the address Base + 13 and Base + 14 are used for digital output channels.

Address : BASE + 6 & BASE + 7

Attribute: read only

Data Format:

Bit	7	6	5	4	3	2	1	0
Base + 6	DI7	DI6	DI5	DI4	DI3	DI2	DI1	DI0
Base + 7	DI15	DI14	DI13	DI12	DI11	DI10	DI9	DI8

Address : BASE + 13 & BASE + 14

Attribute: write only

Data Format:

Bit	7	6	5	4	3	2	1	0
Base + 13	DO7	DO6	DO5	DO4	DO3	DO2	DO1	DO0
Base + 14	DO15	DO14	DO13	DO12	DO11	DO10	DO9	DO8

3.9 D/A Output Register

The D/A converter will convert the D/A output register data to the analog signal. The register data of the address Base + 4 and Base + 5 are used for D/A channel 1, Base +6 and Base +7 are used for D/A channel 2.

Address : BASE + 4 & BASE + 5

Attribute: write only

Data Format: (for D/A Channel 1)

Bit	7	6	5	4	3	2	1	0
Base + 4	DA7	DA6	DA5	DA4	DA3	DA2	DA1	DA0
Base + 5	X	X	X	X	DA11	DA10	DA9	DA8

Address : BASE + 6 & BASE + 7

Attribute: write only

Data Format: (for D/A Channel 2)

Bit	7	6	5	4	3	2	1	0
Base + 6	DA7	DA6	DA5	DA4	DA3	DA2	DA1	DA0
Base + 7	X	X	X	X	DA11	DA10	DA9	DA8

DA0 is the LSB and DA11 is the MSB of the 12 bits data.

X: don't care

Note: The D/A registers are "**double buffered**" so that the D/A analog output signals will not updated until the second (**high**) byte is written. This can insure a single step transition when the D/A conversion.

3.10 Internal Timer/Counter Register

Two counter of 8254 are used for periodically triggering the A/D conversion, the left one is left free for user applications. The 8254 occupies 4 I/O address locations in the ACL-8216 as shown blow. Users can refer to NEC's or Intel's data sheet for a full description of the 8254 features, condensed information is specified in Appendix B.

Address : BASE + 0 ~ BASE + 3

Attribute: read / write

Data Format:

Base + 0	Counter 0 Register (R/W)
----------	---------------------------

Base + 1	Counter 1 Register (R/W)
Base + 2	Counter 2 Register (R/W)
Base + 3	8254 CONTROL BYTE

4

Operation Theorem

The operation theorem of the functions on ACL-8216 card is described in this chapter. These functions include the A/D conversion, D/A conversion, digital I/O and counter / timer. The operation theorem can help you to understand how to manipulate or to program the ACL-8216.

4.1 A/D Conversion

Before programming the ACL-8216 to perform the A/D conversion, you should understand the following issues:

- A/D conversion procedure
- A/D trigger mode
- A/D data transfer mode
- Signal connection

4.1.1 A/D Conversion Procedure

The A/D conversion is started by a trigger source, then the A/D converter will start to convert the signal to a digital value. The ACL-8216 provides three trigger modes, see section 5.1.2.

While A/D conversion, the *DRDY* bit in Status Control register is cleared to indicate that the data is not ready. After conversion being completed, the *DRDY* bit will return to low(0) level. It means users

can read the converted data from the A/D data registers. Please refer section 4.2 for the A/D data format.

The A/D data should be transferred into PC's memory for further using. The ACL-8216 provides three data transfer modes that allow users to optimize the DAS system. Refer to section 5.1.3 for data transfer modes.

4.1.2 A/D Trigger Modes

In the ACL-8216, A/D conversion can be triggered by the *Internal* or *External* trigger source. The jumper JP4 is used to select the internal or external trigger, please refer to section 2.8 for details. whenever the external source is set, the internal sources are disable.

The two internal sources are the software trigger and the timer pacer trigger which is controlled by the A/D operation mode control register (BASE+11). Total three trigger sources are possible in the ACL-8216. The different trigger conditions are specified as follows:

Software trigger

The trigger source is software controllable in this mode. That is, the A/D conversion starts when any value is written into the software trigger register (BASE+12). This trigger mode is suitable for low speed A/D conversion. Under this mode, the timing of the A/D conversion is fully controlled under software. However, it is difficult to control the fixed A/D conversion rate except another timer interrupt service routine is used to generate a fixed rate trigger.

Timer Pacer Trigger

An on-board timer / counter chip 8254 is used to provide a trigger source for A/D conversion at a fixed rate. Two counters of the 8254 chip are cascaded together to generate trigger pulse with precise period. Please refer to section 5.4 for 8254 architecture. This mode is ideal for high speed A/D conversion. It can be combined with the DMA or the interrupt data transfer. It's recommend to use this mode if your applications need a fixed and precise A/D sampling rate.

External Trigger

Through the pin-17 of CN3 (*ExtTrig*), the A/D conversion also can be performed when the a rising edge of external signal occurs. The conversion rate of this mode is more flexible than the previous two

modes, because the users can handle the external signal by outside device. The external trigger can combine with the DMA transfer, interrupt data transfer, or even program polling data transfer. Generally, the interrupt data transfer is often used when external trigger mode is used.

4.1.3 A/D Data Transfer Modes

On the ACL-8216, three A/D data transfer modes can be used when the conversion is completed. The data transfer mode is controlled by the mode control register (BASE+11). The different transfer modes are specified as follows:

Software Data Transfer

Usually, this mode is used with software A/D trigger mode. After the A/D conversion is triggered by software, the software should poll the *DRDY* bit until it becomes to high level. Whenever the low byte of A/D data is read, the *DRDY* bit will be cleared to indicate the data is read out.

It is possible to read A/D converted data without polling. The A/D conversion time will not exceed 8 μ s on ACL-8216 card. Hence, after software trigger, the software can wait for at least 10 μ s then read the A/D register without polling.

Interrupt Transfer

The ACL-8216 provides hardware interrupt capability. Under this mode, an interrupt signal is generated when the A/D conversion is ended and the data is ready to be read. It is useful to combine the interrupt transfer with the timer pacer trigger mode. Under this mode, the data transfer is essentially asynchronous with the control software.

When the interrupt transfer is used, you have to set the interrupt IRQ level by hardware jumper. Please refer section 2.10 for IRQ jumper setting. After the A/D conversion is completed, a hardware interrupt will be inserted and its corresponding ISR (Interrupt Service Routine) will be invoked and executed. The converted data is transferred by the ISR program.

DMA Transfer

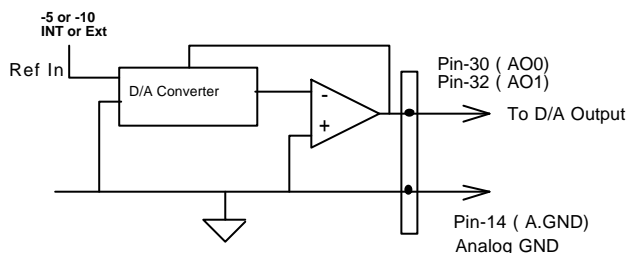
The DMA (Direct Memory Access) allows data to be transferred

directly between the ACL-8216 and the PC' s memory at the fastest possible rate, without using any CPU time. The A/D data is automatically transferred to PC's memory after conversion completed.

The DMA transfer mode is very complex to program. It is recommended to use the high level program library to operate this card. If you wish to program the software which can handle the DMA data transfer, please refer to more information about 8237 DMA controller.

4.2 D/A Conversion

The ACL-8216 has two unipolar analog output channels. To make the D/A output connections from the appropriate D/A output, please refer the following figure:



The operation of D/A conversion is more simple than A/D operation. You only need to write digital values into the D/A data registers and the corresponding voltage will be output from the AO1 or AO2. Refer to section 4.9 for information about the D/A data registers. The mathematical relationship between the digital number DAn and the output voltage is formulated as following:

$$V_{out} = -V_{ref} \times \frac{DAn}{4096}$$

where the V_{ref} is the reference voltage, the V_{out} is the output voltage, and the DAn is the digital value in D/A data registers.

Before performing the D/A conversion, users should care about the

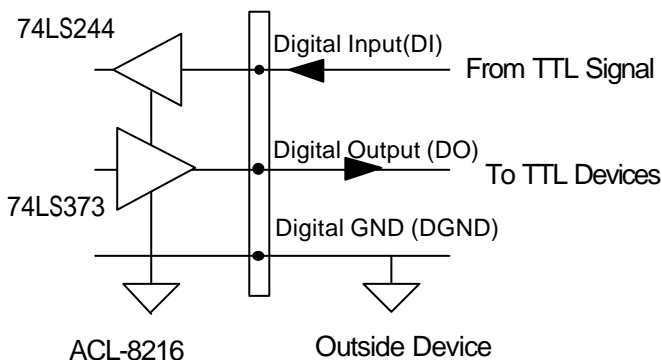
D/A reference voltage which set by the JP1,JP2 and JP3. Please refer section 2.11 for jumper setting. The reference voltage will effect the output voltage. If the reference voltage is -5V, the D/A output scaling will be 0~5V. If the reference voltage is -10V, the D/A output scaling will be 0~10V.

Note that the D/A registers are "**double buffered**", so that the D/A analog output signals will not be updated until the high byte is written. When write 12 bits data to D/A registers of the ACL-8216, the low byte must be written before the high byte. This procedure can insure a single step transition when the D/A conversion.

4.3 Digital Input and Output

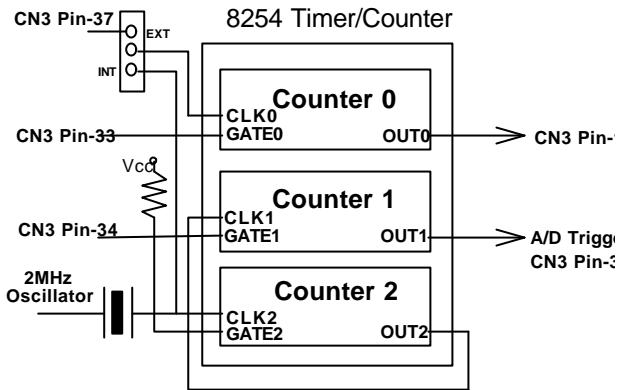
To program digital I/O operation is fairly straight forward. The digital input operation is just to read data from the corresponding registers, and the digital output operation is to write data to the corresponding registers. The digital I/O registers ' format are shown in section 4.9. Note that the DIO data channel can only be read or written in form of 8 bits together. It is impossible to access individual bit channel.

The ACL-8216 provides 16 digital input and 16 digital output channels through the connector CN1 and CN2 on board. The digital I/O signal are fully TTL/DTL compatible. The detailed digital I/O signal specification can be referred in section 1.3.



4.4 Timer/Counter Operation

The ACL-8216 has an interval timer/counter 8254 on board. It offers 3 independent 16-bit programmable down counters; counter 1 and counter 2 are cascaded together for A/D timer pacer trigger of A/D conversion. and counter 0 is free for your applications. The following figure shows the 8254 timer/counter connection.



The clock source of counter 0 can be internal or external, while the gate can be controlled externally and the output is send to the connector CN3. As to counter 0 and counter 1, the clock source is internally fixed, while the gate can be controlled externally and the output is send to the connector CN3 too. All the timer/ counter signals are TTL compatible.

The 8254 Timer / Counter Chip

The Intel (NEC) 8254 contains three independent, programmable, multi-mode 16 bit counter/timers. The three independent 16 bit counters can be clocked at rates from DC to 5 MHz. Each counter can be individually programmed with 6 different operating modes by appropriately formatted control words. The most commonly uses for the 8254 in microprocessor based system are:

- programmable baud rate generator
- event counter
- binary rate multiplier
- real-time clock
- digital one-shot

- motor control

For more information about the 8254 , please refer to the NEC Microprocessors and peripherals or Intel Microsystems Components Handbook.

Pacer Trigger Source

The counter 1 and counter 2 are cascaded together to generate the timer pacer trigger of A/D conversion. The frequency of the pacer trigger is software controllable. The maximum pacer signal rate is $2\text{MHz}/4=500\text{K}$ which excess the maximum A/D conversion rate of the ACL-8216. The minimum signal rate is $2\text{MHz}/65535/65535$, which is a very slow frequency that user may never use it.

General Purpose Timer/ Counter

The counter 0 is free for users' applications. The clock source, gate control signal and the output signal is send to the connector CN3. The general purpose timer / counter can be used as event counter, or used for measuring frequency, or others functions. See the 'Timer/Counter Applications' section for examples.

I/O Address

The 8254 in the ACL-8216 occupies 4 I/O address as shown below.

BASE + 0	LSB OR MSB OF COUNTER 0
BASE + 1	LSB OR MSB OF COUNTER 1
BASE + 2	LSB OR MSB OF COUNTER 2
BASE + 3	CONTROL BYTE

The programming of 8254 is control by the registers BASE+0 to BASE+3. The functionality of each register is specified this section. For more detailed information, please refer handbook of 8254 chip.

Control Byte

Before loading or reading any of these individual counters, the control byte (BASE+3) must be loaded first. The format of the control byte is:

Bit	7	6	5	4	3	2	1	0
-----	---	---	---	---	---	---	---	---

	SC	SC	RL	RL	M2	M1	M0	BCD
	1	0	1	0				

- SC1 & SC0 - Select Counter (Bit7 & Bit 6)

SC1	SC0	COUNTER
0	0	Select Counter 0
0	1	Select Counter 1
1	0	Select Counter 2
1	1	ILLEGAL

- RL1 & RL0 - Select Read/Load operation (Bit 5 & Bit 4)

RL1	RL0	OPERATION
0	0	COUNTER LATCH FOR STABLE READ
0	1	READ/LOAD LSB ONLY
1	0	READ/LOAD MSB ONLY
1	1	READ/LOAD LSB FIRST, THEN MSB

- M2, M1 & M0 - Select Operating Mode (Bit 3, Bit 2, & Bit 1)

M2	M1	M0	MODE
0	0	0	0
0	0	1	1
x	1	0	2
x	1	1	3
1	0	0	4
1	0	1	5

- BCD - Select Binary/BCD Counting (Bit 0)

0	16-BITS BINARY COUNTER
1	BINARY CODED DECIMAL (BCD) COUNTER (4 DIGITAL)
Note	The count of the binary counter is from 0 up to 65,535 and the count of the BCD counter is from 0 up to 9,999

Mode Definitions

In 8254, six operating modes can be selected. they are:

- **Mode 0:** Interrupt on Terminal Count
- **Mode 1:** Programmable One-Shot.
- **Mode 2:** Rate Generator.

- **Mode 3:** Square Wave Rate Generator.
- **Mode 4:** Software Triggered Strobe.
- **Mode 5:** Hardware Triggered Strobe.

All detailed description of these six modes are written in Intel Microsystems Components Handbook Volume II Peripherals.

5

C/C++ Library

This chapter describes the DOS software library, which is free supplied. The DOS library software includes a utility program, C language library, and some demonstration programs, which can help you reduce the programming work.

To program in Windows environment, please use ACLS-DLL2. The function reference manual of ACLS-DLL2 is included in the ADLINK CD. It needs license.

5.1 Installation

To install the DOS library software and utilities, please follow the following installation procedures:

1. Put *ADLINK CD* into the appropriate CD-ROM drive.
2. Type the following commands to change to the card's directory (*X* indicates the CD-ROM drive):

```
X:\>CD \NuDAQISA\8216
```

3. Execute the setup batch program to install the software:

```
X:\NuDAQISA\8216>SETUP
```

There are 23 function calls provided by the C Language Library, all the functions of ACL-8216 are covered by this library, its capabilities include A/D conversion, D/A conversion, Digital Input and Output, etc.

5.2 `_8216_Initial`

@ Description

An ACL-8216 card is initialized according to the card number and the corresponding base address. Every ACL-8216 Multi-Function Data Acquisition Card have to be initialized by this function before calling other functions.

@ Syntax

```
int _8216_Initial(int card_number, int
                 base_address )
```

@ Argument

card_number: The card number to be initialized, only two cards can be initialized, the card number must be `CARD_1` or `CARD_2`.

base_address: The I/O port base address of the card .

@ Return Code

```
ERR_NoError
ERR_InvalidBoardNumber
ERR_BaseAddressError
```

@ Example

```
#include "8216.h"
#include "aclerr.h"
main()
{
    int ErrCode;

    Errcode = _8216_Initial( CARD_1, 0x210 );
    if( ErrCode != ERR_NoError ) exit(0);

    ErrCode = _8216_Initial( CARD_2, 0x220 );
    if( ErrCode != ERR_NoError ) exit(0);
    .
    .
    .
}
```

5.3 `_8216_Switch_Card_No`

@ Description

This function is used on dual-cards system. After initialized two ACL-8216 cards, this function is used to select which card is used currently.

Note: In this library, only two ACL-8216 can be initialized. The reason is only two DMA channels are supported in the card.

@ Syntax

```
int _8216_Switch_Card_No(int card_number)
```

@ Argument

card_number: The card number to be initialized, only two cards can be initialized, the card number must be `CARD_1` or `CARD_2`.

@ Return Code

```
ERR_NoError  
ERR_InvalidBoardNumber
```

@ Example

```
#include "8216.h"  
  
main()  
{  
  _8216_Initial( CARD_1, 0x210 );  
  _8216_Initial( CARD_2, 0x220 );  
  /* Assume NoError when Initialize ACL-8216 */  
  
  _8216_Switch_Card_No( Card_1 );  
  /* ..... You can perform certain functions  
  to Card_1 here*/  
  
  _8216_Switch_Card_No( Card_2 );  
  /* ..... You can perform certain functions  
  to Card_2 here*/  
  
}
```

5.4 _8216_DI

@ Description

This function is used to read data from digital input port. There are 16 bits of digital input on the ACL-8216. The bit 0 to bit 7 are defined as **low byte** and the bit 8 to bit 15 are defined as the **high byte**.

@ Syntax

```
int _8216_DI( int port_number, unsigned char *data )
```

@ Argument

port_number: To indicate which port is read,
DI_LOW_BYTE
or DI_HIGH_BYTE.
DI_LOW_BYTE: bit 0 ~ bit 7,
DI_HIGH_BYTE: bit8 ~ bit15

data: return value from digital port.

@ Return Code

ERR_NoError
ERR_BoardNoInit
ERR_PortError

@ Example

See demo program 'DI_DEMO.C'

5.5 _8216_DI_Channel

@ Description

This function is used to read data from digital input channels (bit). There are 16 digital input channels on the ACL-8216. When performs this function, the digital input port is read and the value of the corresponding channel is returned.

* channel means each bit of digital input ports.

@ Syntax

```
int _8216_DI(int di_ch_no, unsigned int *data )
```

@ Argument

di_ch_no: the DI channel number, the value has to
be set from 0 to 15.

data: return value, either 0 or 1.

@ Return Code

ERR_NoError
ERR_BoardNoInit
ERR_InvalidDIChannel

@ Example

```
#include "8216.h"

main()
{
    unsigned int data;
    int ch;

    _8216_Initial( CARD_1, 0x220 );
    /* Assume NoError when Initialize ACL-8216 */
    for( ch=0; ch<16; ch++ )
    {
        _8216_DI_channel( ch , &data );
        printf( "The value if DI channel %d is
%d.\n" , ch , data );
    }
}
```

5.6 _8216_DO

@ Description

This function is used to write data to digital output ports. There are 16 digital outputs on the ACL-8216, they are divided by two ports, DO_LOW_BYTE and DO_HIGH_BYTE. The channel 0 to channel 7 are defined in DO_LOW_BYTE port and the channel 8 to channel 15 are defined as the DO_HIGH_BYTE port.

@ Syntax

```
int _8216_DO(int port_number, unsigned char data )
```

@ Argument

port_number: DO_LOW_BYTE or DO_HIGH_BYTE
data: value will be written to digital output port

@ Return Code

ERR_NoError
ERR_BoardNoInit
ERR_PortError

@ Example

```
#include "8216.h"
main()
{
    _8216_Initial( CARD_1, 0x220 );
```

```

/* Assume NoError when Initialize ACL-8216 */

    _8216_DO( DO_LO_BYTE , 0x55 );
    printf( "The low byte is now 0x55.\n" );

    _8216_DO( DO_HI_BYTE , 0xAA );
    printf( "The high byte is now 0xAA.\n" );

}

```

A more detailed example program is provided.
('DO_DEMO.C')

5.7 _8216_DA

@ Description

This function is used to write data to D/A converters. There are two Digital-to-Analog conversion channels on the ACL-8216. The resolution of each channel is 12-bit, i.e. the range is from 0 to 4095.

@ Syntax

```
int _8216_DA(int da_ch_no, unsigned int data )
```

@ Argument

da_ch_no: D/A channel number
data: D/A converted value, if the value is greater than 4095, the higher 4-bits are negligent.

@ Return Code

```

ERR_NoError
ERR_BoardNoInit
ERR_InvalidDAChannel

```

@ Example

```

#include "8216.h"

main()
{

    _8216_Initial( CARD_1, 0x220 );
    /* Assume NoError when Initialize ACL-8216 */
    /* If the hardware setting for DA output is 0~5V
    */

    _8216_DA( CH_1 , 0x800 );

```

```
    printf( "The output voltage of CH1 is 2.5V.\n" );  
    _8216_DA( CH_2 , 0xFFFF );  
    printf( " The output voltage of CH2 is 5V.\n" );  
  
}
```

A more detailed example program is provided.
('DA_DEMO.C')

5.8 _8216_AD_Input_Mode

@ Description

This function is only useful for ACL-8216 ver. B series. This function is used to set A/D input mode to single-ended or differential mode. The default mode of A/D input is single-ended, so the A/D channel number can be set between 0 to 15. If the A/D mode is set as differential, the input channel can be selected from channel 0 to 7 only. You have to call this function before the A/D operation is processed.

@ Syntax

```
int _8216_Input_Mode(int ad_mode )
```

@ Argument

ad_mode:	SINGLE_ENDED:	the analog inputs are single-ended mode
	DIFFERENTIAL:	the analog inputs are single-ended mode

@ Return Code

```
ERR_NoError  
ERR_BoardNoInit
```

@ Example

```
#include "8216.h"  
  
main()  
{  
  
    _8216_Initial( CARD_1, 0x210 );  
    /* Assume NoError when Initialize ACL-8216 */  
    _8216_Initial( CARD_2, 0x220 );  
    /* Assume NoError when Initialize ACL-8216 */  
  
    _8216_AD_Input_Mode( DIFFERENTIAL );  
    /* set analog input mode as "differential" mode  
*/  
    /* if this function is not called, the default  
input mode is single-ended mode */  
    _8216_Switch_Card_No( CARD_1 );  
    _8216_AD_Input_Mode( SINGLE_ENDED );  
    ...  
    _8216_AD_Set_Channel( 3 );  
}
```

```

printf( " AD channel 3 is now selected.\n" );
...
/* the following A/D's operation is based on
channel 3 */
}

```

5.9 _8216_AD_Set_Channel

@ Description

This function is used to set AD channel by means of writing data to the channel multiplexer register. There are 16 single-ended A/D channels in ACL-8216, so the channel number should be set between 0 to 15 only. The initial state is channel 0 which is a default setting by the ACL-8216 hardware configuration.

@ Syntax

```
int _8216_AD_Set_Channel( int ad_ch_no )
```

@ Argument

ad_ch_no: channel number to perform AD conversion
Single-ended mode: Channel no. is from
0~15
Differential mode: Channel no. is from
0~7

@ Return Code

```

ERR_NoError
ERR_BoardNoInit
ERR_InvalidADChannel

```

@ Example

```

#include "aclerr.h"
#include "8216.h"

main()
{

    _8216_Initial( CARD_1, 0x220 );
    /* Assume NoError when Initialize ACL-8216 */

    _8216_AD_Set_Channel( 3 );
    printf( "AD channel 3 is now selected.\n" );

    /* the following A/D's operation is based on channel 3
    */
}

```

}

5.10 _8216_AD_Set_Range

@ Description

This function is used to set the A/D range by means of writing data to the A/D range control register. There are two factors will change the analog input range- Gain and Input type. The Gain can be choice from 1,2,4 and 8. The initial value of gain is '1' which is set by the ACL-8216 hardware. The relationship between analog input range and gain is specified by following tables:

Input Range (V)	Gain	Range Code
±5 V	X 1	0
±2.5 V	X 2	1
±1.25 V	X 4	2
±0.625 V	X 8	3

@ Syntax

```
int _8216_AD_Set_Range( int range_code )
```

@ Argument

range_code: the programmable range of A/D conversion, the possible values.

@ Return Code

```
ERR_NoError  
ERR_BoardNoInit  
ERR_AD_InvalidGain
```

@ Example

```
#include "8216.h"  
  
main()  
{  
  
    _8216_Initial( CARD_1, 0x220 );  
    /* Assume NoError when Initialize ACL-8216 */  
  
    _8216_AD_Set_Range( 1 );  
    printf( "The A/D analog input range is +/-5V.\n" );  
    ...  
}
```

5.11 _8216_AD_Set_Mode

@ *Description*

This function is used to set the A/D trigger and data transfer mode by means of writing data to the mode control register. The hardware initial state of the ACL-8216 is set as AD_MODE_1 software(internal) trigger with program polling data.

A/D Mode	Description
AD_MODE_0	External Trigger, Software Polling
AD_MODE_1	Software Trigger, Software Polling
AD_MODE_2	Timer Trigger, DMA Transfer
AD_MODE_3	External Trigger, DMA Transfer
AD_MODE_4	External Trigger, Interrupt Transfer
AD_MODE_5	Software Trigger, Interrupt Transfer
AD_MODE_6	Timer Trigger, Interrupt Transfer
AD_MODE_7	Not Used

Note: The analog input mode selection should go with the hardware setting, which is described in chapter 2.

@ *Syntax*

```
int _8216_AD_Set_Mode(int ad_mode )
```

@ *Argument*

ad_mode: AD trigger and data transfer mode

@ *Return Code*

```
ERR_NoError  
ERR_BoardNoInit  
ERR_InvalidMode
```

@ *Example*

```
#include "8216.h"  
  
main()  
{  
  
_8216_Initial( CARD_1, 0x220 );  
/* Assume NoError when Initialize ACL-8216 */  
  
_8216_AD_Set_Mode( AD_Mode_0 );  
printf( "Now, disable internal trigger.\n" );  
}
```

}

5.12 _8216_AD_Soft_Trig

@ Description

This function is used to trigger the A/D conversion by software. When the function is called, a trigger pulse will be generated and the converted data will be stored in the base address Base +4 and Base +5.

@ Syntax

```
int _8216_AD_Soft_Trig( void )
```

@ Argument

None

@ Return Code

ERR_NoError

ERR_BoardNoInit

@ Example

```
#include "8216.h"

main()
{
    _8216_Initial( CARD_1, 0x220 );
    /* Assume NoError when Initialize ACL-8216 */

    _8216_AD_Soft_Trig();
    printf( "Now, AD is triggered.\n" );
    .
    .
    _8216_AD_Acquire( &data);
}
```

5.13 _8216_AD_Acquire

@ Description

This function will set the A/D mode as AD_MODE_1 (Software trigger, Software polling), generate a software trigger to begin A/D conversion, then poll the A/D conversion data. It reads the 16-bit A/D data until the data is ready ('data ready' bit becomes low).

@ Syntax

```
int _8216_AD_Aquire( int *ad_data )
```

@ Argument

ad_data: 16-bit A/D converted value, the value should
within -32768 to 32767

@ Return Code

```
ERR_NoError  
ERR_BoardNoInit  
ERR_AD_AquireTimeOut
```

@ Example

```
#include "aclerr.h"  
#include "8216.h"  
  
main()  
{  
    int ad_data;  
    int ErrCode;  
  
    _8216_Initial( CARD_1, 0x220 );  
    /* Assume NoError when Initialize ACL-8216 */  
  
    /* Set to software trigger at first*/  
    /* then trigger the AD */  
    /* wait for AD data ready then read it */  
    ErrCode = _8216_AD_Aquire( &ad_data );  
  
    if( ErrCode == ERR_NoError )  
        printf( "The AD value is %d.\n", ad_data );  
    else  
        printf( "AD conversion error happen\n" );  
}
```

Also see demo program 'AD_DEMO.C'.

5.14 _8216_CLR_IRQ

@ Description

This function is used to clear interrupt request which requested by the ACL-8216. If you use interrupt to transfer A/D converted data, you should use this function to clear interrupt request status, otherwise no new coming interrupt will be generated.

@ Syntax

```
int _8216_CLR_IRQ( void )
```

@ Argument

None

@ Return Code

```
ERR_NoError  
ERR_BoardNoInit
```

@ Example

```
#include "8216.h"  
  
main()  
{  
    int ad_data;  
    int ErrCode;  
    _8216_Initial( CARD_1, 0x220 );  
    /* Assume NoError when Initialize ACL-8216 */  
  
    _8216_CLR_IRQ();  
    /* clear IRQ if necessary */  
}
```

5.15 _8216_AD_DMA_Start

@ Description

The function will perform A/D conversion N times with DMA data transfer by using the pacer trigger (internal timer trigger). It will takes place in the background which will not stop until the N-th conversion has completed or your program execute _8216_AD_DMA_Stop() function to stop the process. After executing this function, it is necessary to check the status of the operation by using the function _8216_AD_DMA_Status(). The function is performed on single A/D channel with fixed gain. The sampling rate is 2 MHz/(c1xc2).

@ Syntax

```
int _8216_DMA_Start( int ad_ch_no, int ad_range,  
                    int dma_ch_no, int irq_ch_no
```

```
int count , int *ad_buffer  
unsigned int c1, unsigned int c2)
```

@ Argument

ad_ch_no: A/D channel number
ad_gain: A/D range value

Input Range (V)	Gain	Range Code
± 10 V	X1	0
± 5 V	X2	1
± 2.5 V	X4	2
± 1.25 V	X8	3

dma_ch_no: DMA channel number, DMA_CH_1 or DMA_CH_3. This should be the same as the setting of JP8 and JP9 on hardware.

irq_ch_no: IRQ channel number, used to stop DMA. This should be the same as the setting of JP7 on hardware.

count: the numbers of A/D conversion

ad_buffer: the start address of the memory buffer to store the AD data, the buffer size must large than the number of AD conversion.

c1: the 16-bit timer frequency divider of timer channel #1

c2: the 16-bit timer frequency divider of timer channel #2

@ Return Code

ERR_NoError
ERR_BoardNoInit, ERR_InvalidADChannel,
ERR_AD_InvalidGain, ERR_InvalidDMAChannel,
ERR_InvalidIRQChannel, ERR_InvalidTimerValue

@ Example

See demo program 'AD_Demo4.C'

5.16 _8216_AD_DMA_Status

@ Description

Since the `_8216_AD_DMA_Start` function is executed in background, you can issue the function `_8216_AD_DMA_Status` to check its operation status.

@ Syntax

```
int _8216_AD_DMA_Status( int *status , int *count )
```

@ Argument

status: status of the DMA data transfer
0: AD DMA is not completed
1: AD DMA is completed

count: the number of A/D data which has been transferred.

@ Return Code

ERR_NoError
ERR_BoardNoInit
ERR_AD_DMAMNotSet

@ Example

See demo program 'AD_Demo4.C'

5.17 _8216_AD_DMA_Stop

@ Description

This function is used to stop the DMA data transfer. After executing this function, the internal A/D trigger is disable and the A/D timer (timer #1 and #2) is stopped. The function returns the number of the data which has been transferred, no matter if the A/D DMA data transfer is stopped by this function or by the DMA terminal count ISR.

@ Syntax

```
int _8216_AD_DMA_Stop( int *count )
```

@ Argument

count: the number of A/D converted data which has been transferred.

@ Return Code

ERR_NoError
ERR_BoardNoInit
ERR_AD_DMAMNotSet

@ Example

See demo program 'AD_Demo4.C'

5.18 _8216_AD_INT_Start

@ Description

The function will perform A/D conversion N times with interrupt data transfer by using pacer trigger. It takes place in the background which will not stop until the N-th conversion has completed or your program execute `_8216_AD_INT_Stop()` function to stop the process. After executing this function, it is necessary to check the status of the operation by using the function `8216_AD_INT_Status()`. The function is perform on single A/D channel with fixed gain. The sampling rate is 2 MHz/(c1xc2).

@ Syntax

```
int _8216_INT_Start( int ad_ch_no, int ad_range,
                    int irq_ch_no, int count, int
                    *ad_buffer,      unsigned int c1, unsigned int c2)
```

@ Argument

ad_ch_no:	A/D channel number
ad_range:	A/D range value
irq_ch_no:	IRQ channel number used to transfer AD data, the possible value is defined in '8216.h'. This should be the same as the setting of JP7 on hardware.
count:	the numbers of A/D conversion
ad_buffer:	the start address of the memory buffer to store the A/D data, the buffer size must be large than the numbers of A/D conversion.
c1:	the 16-bit timer frequency divider of timer channel #1
c2:	the 16-bit timer frequency divider of timer channel #2

@ Return Code

```
ERR_NoError
ERR_Board_NoInit, ERR_AD_InvalidChannel,
ERR_AD_InvalidGain, ERR_InvalidIRQChannel,
ERR_InvalidTimerValue
```

@ Example

See demo program 'AD_Demo2.C'

5.19 _8216_AD_INT_Status

@ Description

Since the `_8216_AD_INT_Start()` function is executed in background, you can issue the function `_8216_AD_INT_Status` to check the status of interrupt operation.

@ Syntax

```
int _8216_AD_INT_Status( int *status , int *count )
```

@ Argument

status: status of the INT data transfer
0: A/D INT is completed
1: A/D INT is not completed

count: current conversion count number.

@ Return Code

ERR_NoError
ERR_BoardNoInit
ERR_AD_INTNotSet

@ Example

See demo program 'AD_Demo2.C'

5.20 _8216_AD_INT_Stop

@ Description

This function is used to stop the interrupt data transfer function. After executing this function, the internal AD trigger is disabled and the AD timer is stopped. The function returns the number of the data which has been transferred, no matter whether the AD interrupt data transfer is stopped by this function or by the `_8216_AD_INT_Start()` itself.

@ Syntax

```
int _8216_AD_INT_Stop( int *count )
```

@ Argument

count: the numbers of A/D data which has been transferred.

@ Return Code

ERR_NoError
ERR_BoardNoInit
ERR_AD_INTNotSet

@ Example

See demo program 'AD_Demo2.C'

5.21 _8216_AD_Timer

@ Description

This function is used to setup the Timer #1 and Timer #2.

Timer #1 & #2 are used as frequency divider for generating constant A/D sampling rate dedicatedly. It is possible to stop the pacer trigger by setting any one of the dividers as 0. Because the AD conversion rate is limited to the conversion time of the AD converter, the highest sampling rate of the ACL-8216 can not be exceeded 100 KHz. Thus the multiplication of the dividers must be larger than 20.

@ Syntax

```
int _8216_AD_Timer( unsigned int c1 , unsigned int c2 )
```

@ Argument

```
c1:          frequency divider of timer #1  
c2:          frequency divider of timer #2,
```

Note: the A/D sampling rate is equal to: $2\text{MHz} / (c1 * c2)$, when $c1 = 0$ or $c2 = 0$, the pacer trigger will be stopped.

@ Return Code

```
ERR_NoError  
ERR_BoardNoInit  
ERR_InvalidTimerValue
```

@ Example

```
main()  
{  
    int ErrCode;  
  
    _8216_Initial( CARD_1, 0x220 );  
    /* Assume NoError when Initialize ACL-8216 */  
  
    _8216_AD_Timer( 10 , 10 );  
    /* set AD sampling rate to 2MHz/(10*10) */  
    _8216_AD_Timer( 0 , 0 );  
    /* stop the pacer trigger */  
}
```

5.22 _8216_Timer_Start

@ Description

The Timer #0 on the ACL-8216 can be freely programmed by the users. This function is used to program the Timer #0. This timer can be used as frequency generator if internal clock is used. It also can be used as event counter if external clock is used. All the 8254 mode are available.

@ Syntax

```
int _8216_Timer_Start( int timer_mode, unsigned int c0 )
```

@ Argument

timer_mode: the 8253 timer mode, the possible values are:
TIMER_MODE0, TIMER_MODE1,
TIMER_MODE2, TIMER_MODE3,
TIMER_MODE4, TIMER_MODE5.

c0: the counter value of timer

@ Return Code

ERR_NoError
ERR_BoardNoInit
ERR_InvalidTimerMode
ERR_InvalidTimerValue

@ Example

See demo program 'TMR_DEMO.C'

5.23 _8216_Timer_Read

@ Description

This function is used to read the counter value of the Timer #0.

@ Syntax

```
int _8216_Timer_Read( unsigned int *counter_value )
```

@ Argument

counter_value: the counter value of the Timer #0

@ Return Code

ERR_NoError
ERR_BoardNoInit

@ Example

See demo program 'TMR_DEMO.C'

5.24 _8216_Timer_Stop

@ Description

This function is used to stop the timer operation. The timer is set to the 'One-shot' mode with counter value '0'. That is, the clock output signal will be set to high after executing this function.

@ Syntax

```
int _8216_Timer_Stop( unsigned int *counter_value )
```

@ Argument

*counter_value: the current counter value of the Timer
#0

@ Return Code

ERR_NoError
ERR_BoardNoInit

@ Example

See demo program 'TMR_DEMO.C'

6

Calibration & Utilities

In data acquisition process, how to calibrate your measurement devices to maintain its accuracy is very important. Users can calibrate the analog input and analog output channels under the users' operating environment for optimizing the accuracy. This chapter will guide you to calibrate your ACL-8216 to an accuracy condition.

6.1 What do you need

Before calibrating your ACL-8216 card, you should prepare some equipment' s for the calibration:

- Calibration program: After finishing the DOS software installation, a utility program 8216util.exe exists in C:\ADLINK\8216\DOS\UTIL directory. Once the program is executed, it will guide you to do the calibration.
- A 6 1/2 digit multimeter (6 1/2 is recommended)
- A voltage calibrator or a very stable and noise free DC voltage generator.

6.2 VR Assignment

There are five variable resistors (VR) on the ACL-8216 board to allow you making accurate adjustment on A/D and D/A channels. The function of each VR is specified as Table 6.1.

VR1	A/D bipolar offset adjustment
-----	-------------------------------

VR2	A/D full scale adjustment
VR3	D/A channel 1 full scale adjustment
VR4	D/A channel 2 full scale adjustment
VR5	A/D programmable amplifier offset adjustment
VR6	D/A reference voltage adjustment

Table 6.1 Function of VRs

6.3 A/D Adjustment

1. Set the analog input range as: +/- 10V, i.e. the gain = 1
2. Short the A/D channel 0 (pin 1 of CN3) to ground(GND), and connect the TP1(+) and TP2(-) with your DVM. Trim the variable resistor VR5 to obtain a value as close as possible to 0V. (You have to keep reading for A/D channel 0).
3. Applied a +10V input signal to A/D channel 1, and short the A/D CH0 to Analog ground(A.GND).
4. Trim VR1 until the reading of CH0 between 0000 ~ 0001(hex).
5. Trim VR2 until the reading of CH1 between 7FFE ~ 7FFF(hex).
6. Repeat step 4 and step 5, adjust until the reading values meet requirements.

Note: When the user trims the VR1 and VR2, it will have side effect on the D/A converted data, so repeat the step 4 and step 5 are very important issue for A/D calibration.

6.4 D/A Adjustment

There are two steps to calibrate the analog output channels, D/A 1 and D/A 2. The first step is to adjust the reference voltage, and the second step is to adjust each channel of D/A.

6.4.1 Reference Voltage Calibration

1. Set reference voltage as -5V (the D/A reference voltage is selected by JP1, see section 2.11).

2. Connect VDM (+) to CN3 pin-11 (V.REF) and VDM(-) to GND.
Trim the variable resistor VR6 to obtain -5V reading in the DVM.

Note: If the reference voltage set as -10V, the connection is the same as -5V, but the reading from DVM should be -10V.

6.4.2 D/A Channel Calibration

D/A CH1 calibration:

1. Connect VDM (+) to CN3 pin-30 (AO1) and VDM(-) to A.GND.
2. Write the digital value 0x0FFF into registers (BASE+ 4 and BASE+ 5)
3. Trim the variable resistor VR3 to obtain +5V reading in the DVM.

D/A CH2 calibration:

1. Connect VDM (+) to CN3 pin-32 (AO2) and VDM(-) to A.GND.
2. Write the digital value 0x0FFF into registers (Base + 6 and + 7)
3. Trim the variable resistor VR4 to obtain +5V reading in the DVM.

A calibration utility is supported in the software diskette which is included in the product package. The detailed calibration procedures and description can be found in the utility. Users only need to run the software calibration utility and follow the procedures. You will get the accurate measure data.

Appendix A Demo Programs

In the software CD, there are 8 demonstration programs. These programs help you to program the application by using C language Library easily. The description of these programs are specified as following:

AD_DEMO1.C:	A/D conversion uses software trigger and program data transfer
AD_DEMO2.C:	A/D conversion uses interrupt and program data transfer
AD_DEMO3.C:	A/D conversion uses DMA data transfer
AD_DEMO4.C:	A/D conversion uses multiple channels and input range programmable, triggers by PC timer, and saves all data to a file 'ad_demo4.dat'.
DA_DEMO.C:	D/A Conversion
DI_DEMO.C:	Read data from digital input channels
DO_DEMO.C:	Write data to digital output channels
TMR_DEMO.C:	Handle 8253 Timer/Counter

Product Warranty/Service

Seller warrants that equipment furnished will be free from defects in material and workmanship for a period of one year from the confirmed date of purchase of the original buyer and that upon written notice of any such defect, Seller will, at its option, repair or replace the defective item under the terms of this warranty, subject to the provisions and specific exclusions listed herein.

This warranty shall not apply to equipment that has been previously repaired or altered outside our plant in any way as to, in the judgment of the manufacturer, affect its reliability. Nor will it apply if the equipment has been used in a manner exceeding its specifications or if the serial number has been removed.

Seller does not assume any liability for consequential damages as a result from our products uses, and in any event our liability shall not exceed the original selling price of the equipment.

The equipment warranty shall constitute the sole and exclusive remedy of any Buyer of Seller equipment and the sole and exclusive liability of the Seller, its successors or assigns, in connection with equipment purchased and in lieu of all other warranties expressed implied or statutory, including, but not limited to, any implied warranty of merchant ability or fitness and all other obligations or liabilities of seller, its successors or assigns.

The equipment must be returned postage-prepaid. Package it securely and insure it. You will be charged for parts and labor if you lack proof of date of purchase, or if the warranty period is expired.